



轴承型号 NAFLU209-27

外形尺寸(mm)

d: 42.862

D: 180

B: 148.5

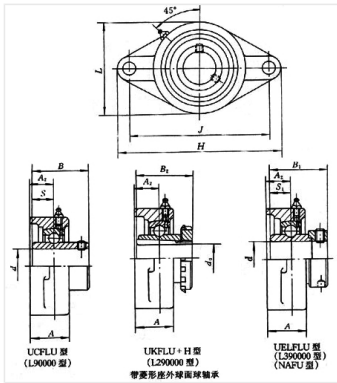

极限转速(rpm)

脂润滑: -

油润滑: -

额定载荷

Cr(N): -

Cr(N): -

重量(kg) 2.25