



轴承型号 K8X11X10

外形尺寸(mm)

d: 8

D: 11

B: 10

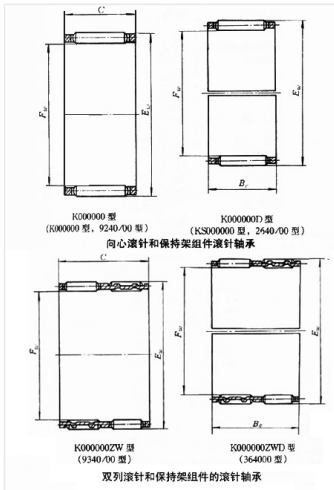

极限转速(rpm)

脂润滑: -

油润滑: -

额定载荷

Cr(N): -

Cr(N): -

重量(kg) -