



轴承型号 ST211-1-3/4

外形尺寸(mm)

d: 44.45

D: 139.7

B: 55.5

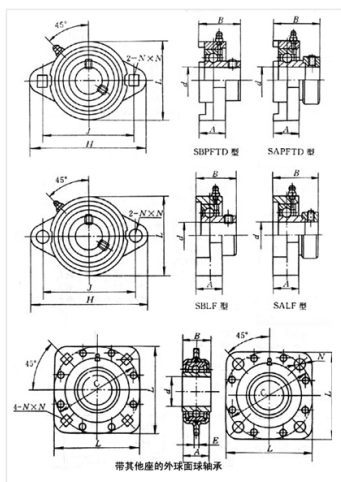

极限转速(rpm)

脂润滑: -

油润滑: -

额定载荷

Cr(N): -

Cr(N): -

重量(kg) 0