



轴承型号 ST211-2-3/16

外形尺寸(mm)

d: 55.563

D: 139.7

B: 55.5

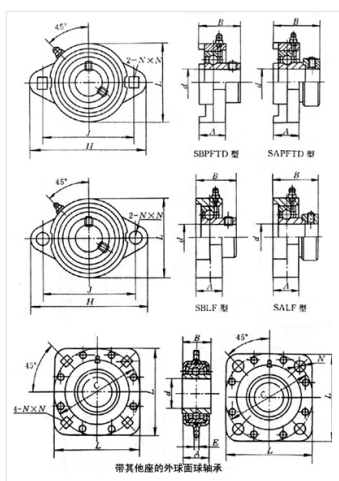

极限转速(rpm)

脂润滑: -

油润滑: -

额定载荷

Cr(N): -

Cr(N): -

重量(kg) 0