



轴承型号 UCHA208

外形尺寸(mm)

d: 40

D: 96

B: 121

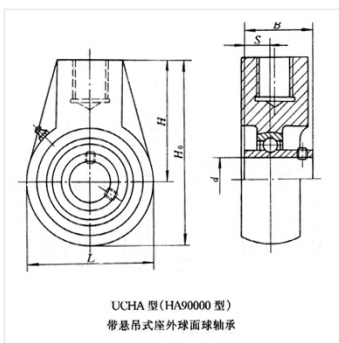

极限转速(rpm)

脂润滑: -

油润滑: -

额定载荷

Cr(N): -

Cr(N): -

重量(kg) 1.5