



轴承型号 UCHA211

外形尺寸(mm)

d: 55

D: 126

B: 150

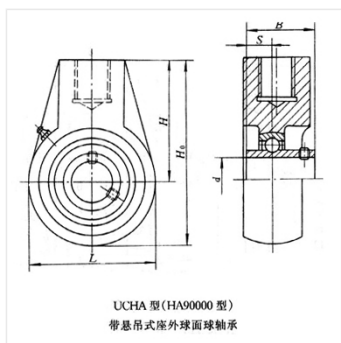

极限转速(rpm)

脂润滑: -

油润滑: -

额定载荷

Cr(N): -

Cr(N): -

重量(kg) 2.9