



轴承型号 UCHA212

外形尺寸(mm)

d: 60

D: 142

B: 173

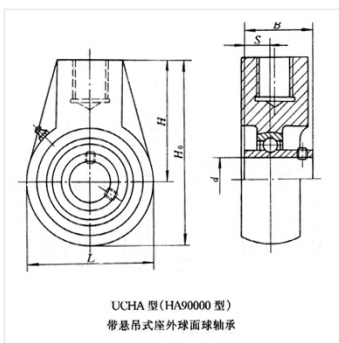

极限转速(rpm)

脂润滑: -

油润滑: -

额定载荷

Cr(N): -

Cr(N): -

重量(kg) 4.4