



轴承型号 UCT210-32

外形尺寸(mm)

d: 50.8

D: 149

B: 117

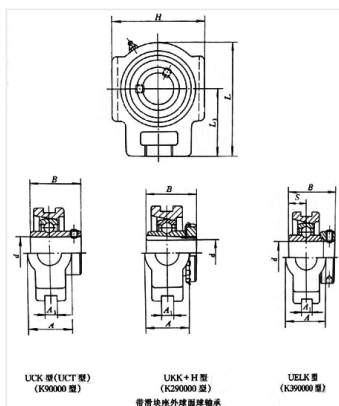

极限转速(rpm)

脂润滑: -

油润滑: -

额定载荷

Cr(N): -

Cr(N): -

重量(kg) 2.6