



轴承型号 UCT215-48

外形尺寸(mm)

d: 76.2

D: 232

B: 167

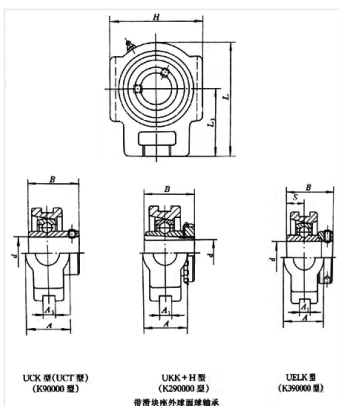

极限转速(rpm)

脂润滑: -

油润滑: -

额定载荷

Cr(N): -

Cr(N): -

重量(kg) 7.5