



轴承型号 UCT212-38

外形尺寸(mm)

d: 60.325

D: 194

B: 146

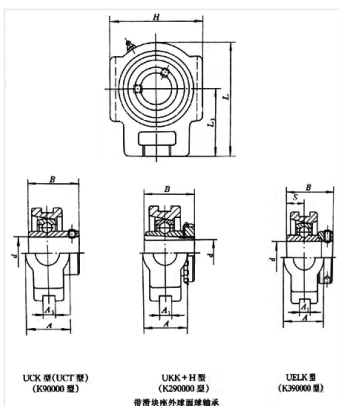

极限转速(rpm)

脂润滑: -

油润滑: -

额定载荷

Cr(N): -

Cr(N): -

重量(kg) 4.9