



轴承型号 UKFC210+H2310

外形尺寸(mm)

d: 45

D: 55

B: 165

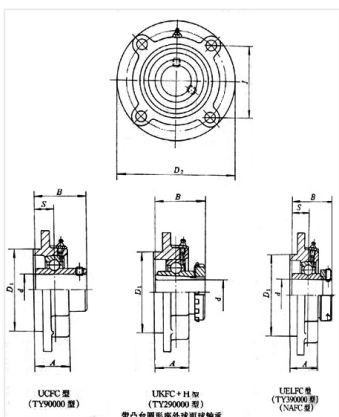

极限转速(rpm)

脂润滑: -

油润滑: -

额定载荷

Cr(N): -

Cr(N): -

重量(kg) -