



轴承型号 51410M

外形尺寸(mm)

d: 50

D: 110

B: 43

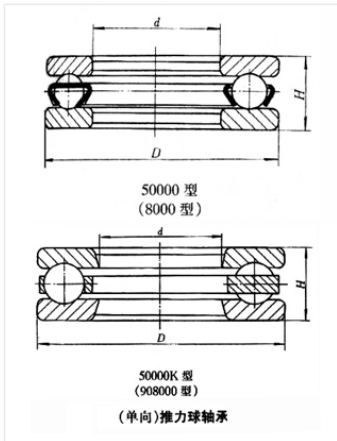

极限转速(rpm)

脂润滑: -

油润滑: -

额定载荷

Cr(N): -

Cr(N): -

重量(kg) 1.86