



轴承型号 517/630

外形尺寸(mm)

d: 630

D: 810

B: 100

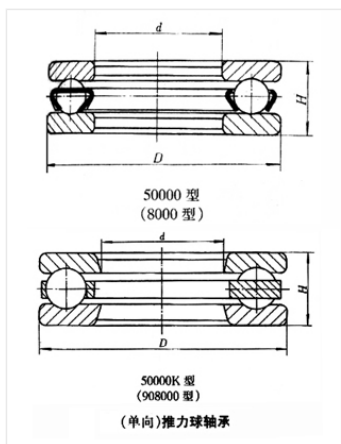

极限转速(rpm)

脂润滑: -

油润滑: -

额定载荷

Cr(N): -

Cr(N): -

重量(kg) 126