



轴承型号 51715

外形尺寸(mm)

d: 75

D: 128

B: 41

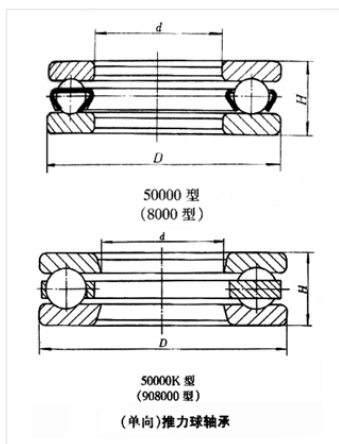

极限转速(rpm)

脂润滑: -

油润滑: -

额定载荷

Cr(N): -

Cr(N): -

重量(kg) 2.18