



轴承型号 NNTUP4205X2/P55

外形尺寸(mm)

d: 25

D: 52

B: 31.2

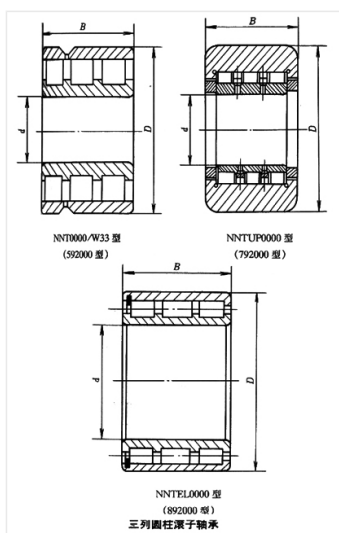

极限转速(rpm)

脂润滑: -

油润滑: -

额定载荷

Cr(N): -

Cr(N): -

重量(kg) -