



轴承型号 NNT2208E/W33

外形尺寸(mm)

d: 40

D: 80

B: 23

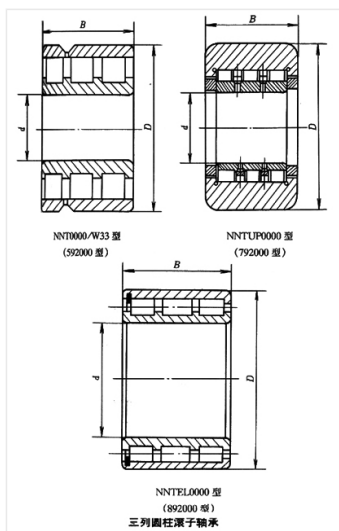

极限转速(rpm)

脂润滑: -

油润滑: -

额定载荷

Cr(N): -

Cr(N): -

重量(kg) 0.54