



轴承型号 2217K+H317

外形尺寸(mm)

d: 75

D: 150

B: 36

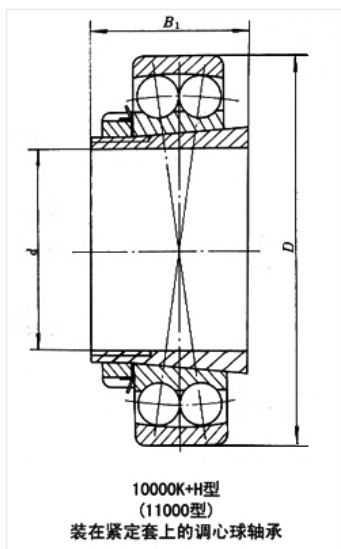

极限转速(rpm)

脂润滑: -

油润滑: -

额定载荷

Cr(N): -

Cr(N): -

重量(kg) -