



轴承型号 2222K+H322

外形尺寸(mm)

d: 100

D: 200

B: 53

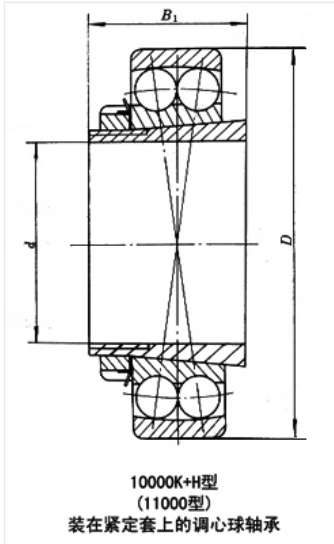

极限转速(rpm)

脂润滑: -

油润滑: -

额定载荷

Cr(N): -

Cr(N): -

重量(kg) -