



轴承型号 6011/Z1

外形尺寸(mm)

d: 55

D: 90

B: 18

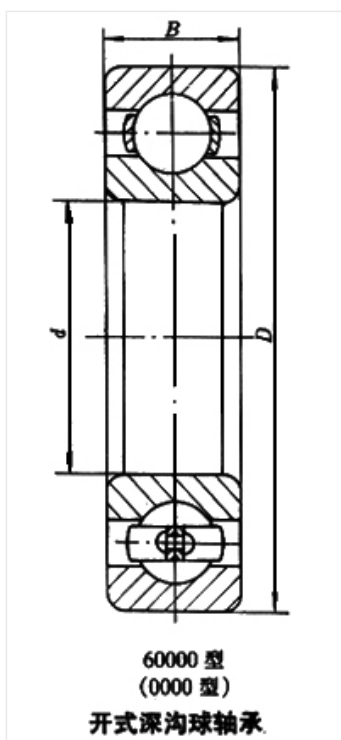

极限转速(rpm)

脂润滑: -

油润滑: -

额定载荷

Cr(N): -

Cr(N): -

重量(kg) 0.38